

Montage / Installation

Schall-Ex[®] L-15/30 WS

Schall-Ex[®] L-15/30 OS

einseitig / single actuation



Lässt niX durch.
DICHTUNGSSYSTEME FÜR
TÜREN UND TORE

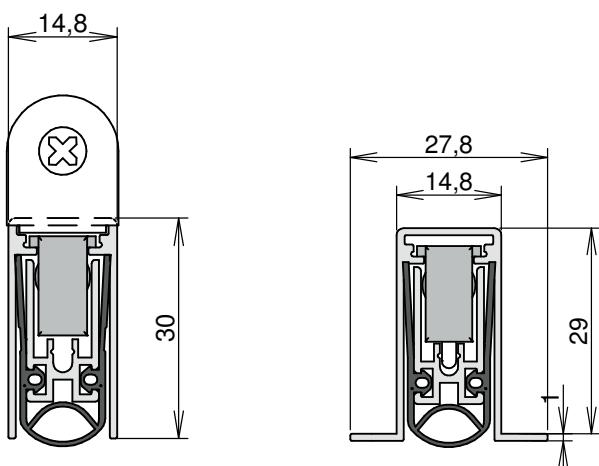

www.athmer.de
www.athmer.de
www.athmer.de

Athmer oHG

Sophienhammer
59757 Arnsberg-Müschede

Tel. +49 2932 477-500

Fax +49 2932 477-100

info@athmer.de

www.athmer.de

Kürzen / cutting to size



Lässt niX durch.
DICHTUNGSSYSTEME FÜR
TÜREN UND TORE

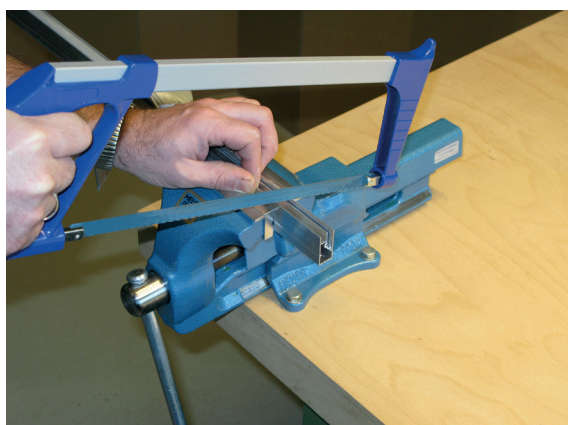
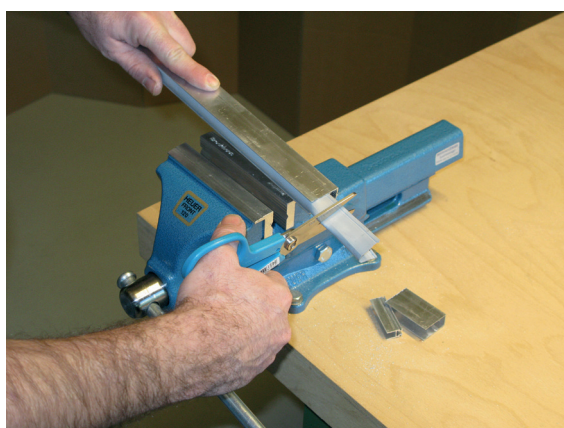
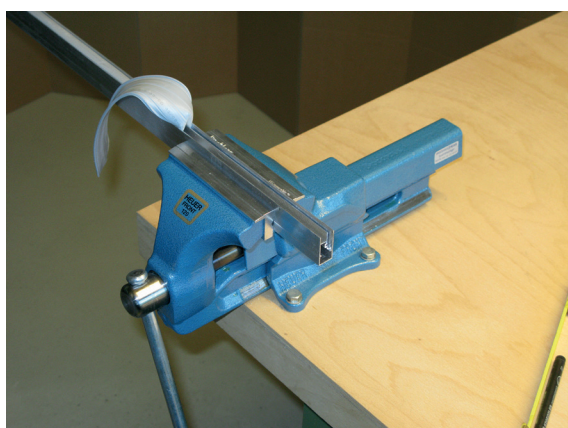
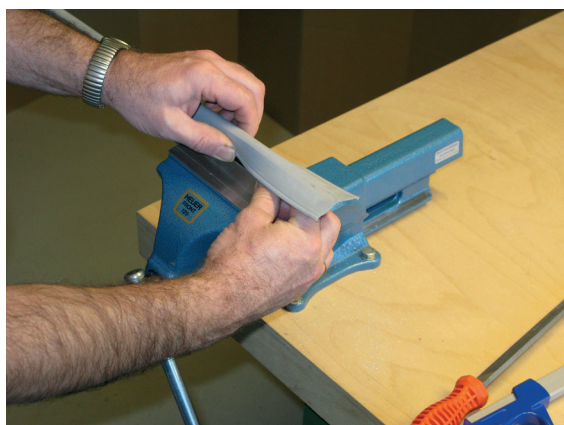
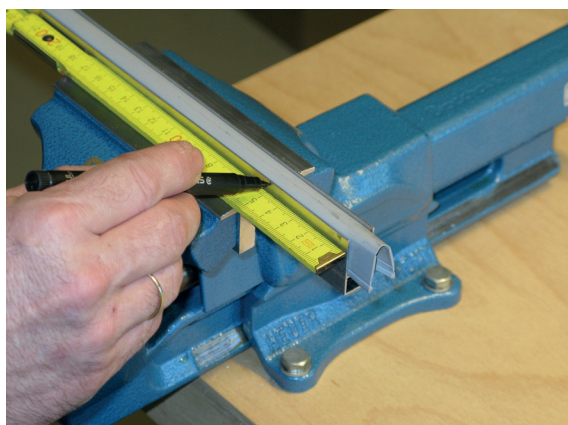
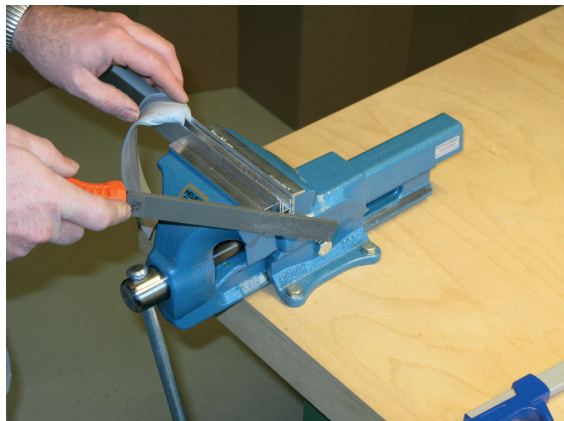

Anschlag / fixing



Lässt niX durch.
DICHTUNGSSYSTEME FÜR
TÜREN UND TORE

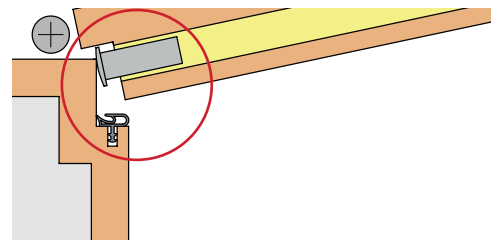
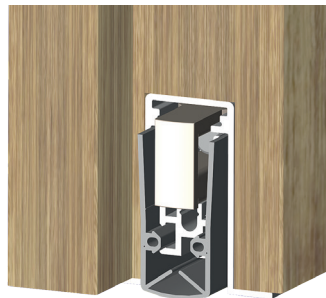
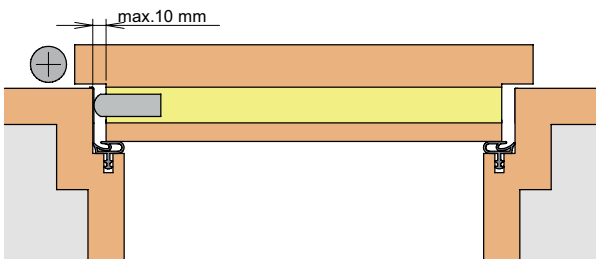

Einstellen / adjustment



Lässt niX durch.
DICHTUNGSSYSTEME FÜR
TÜREN UND TORE

